

LWBE-190 Series



Product Characteristic

- Impeller Material: PA6+GF
- Supply Voltage: 230V,50/60Hz
- Mode Of Operation: S1
- Protection Class: IP55
- Insulation Class: F
- Operation Temperature: -25°C ~ +60°C
- Technical Feature: Control input 0-10VDC/PWM, Tech output, Locked-Rotor protection, Reverse Polarity Over-voltage protection, Soft Start Protection.



Technical Specifications

Model	Voltage (V)	Input Power (W)	Current (A)	Air Volume (m³/h)	Static Pressure (Pa)	Speed (RPM)	Noise [dB(A)]
LWBE3G190-072PS-02	230	115	0.9	855	876	3800	71

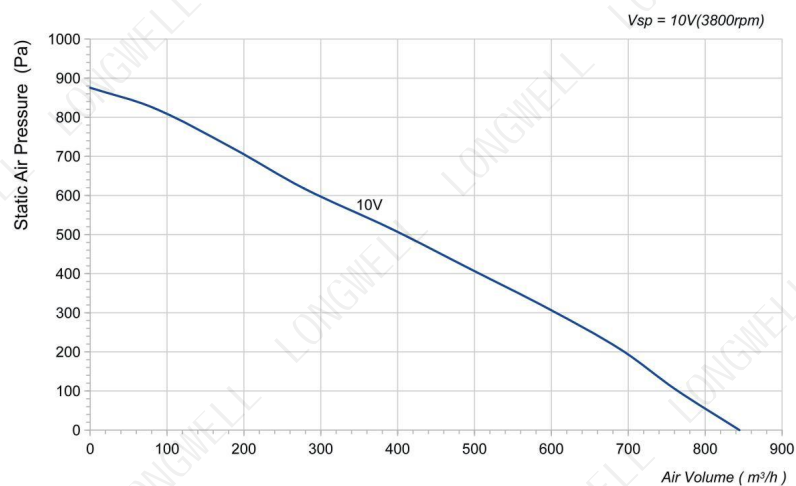

LWBE3G190-072NS-12 (without bracket)

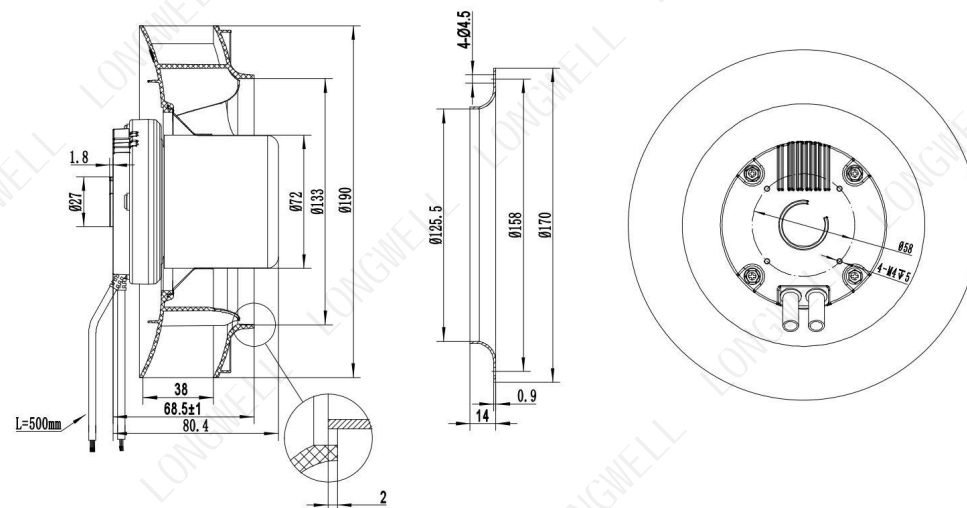

LWBE3G190-072PS-02 (with bracket)

